



# SS1070HF

Jeep JK Wrangler 2012 Model  
3.6Litre VVT V6 Petrol (Pentastar Engine)



18/10/2012

ITEM	PART NO.	DESCRIPTION	QTY
1	956-133-000	BODY - SNORKEL (SS1065HF)	1
2	000-135-800	3 1/2" AIR RAM ASSEMBLY	1
3	956-032-000	BRACKET - UPPER MOUNTING	1
4	000-002-100	BOLT - HEX - 6mm x 1.0 x 14mm (SEMS)	3
5	956-992-000	SPACER - PLASTIC 8.7mmID x 18mm x 4.5mm	2
6	000-110	STUD - S/S - 8mm x 1.25 x 25mm	3
7	000-311-300	WASHER - BODY - 8mm x 30mm - S/S	3
8	000-205-300	NUT - NYLOC - 8mm x 1.25mm - S/S	3
9	956-024-250	HOSE - AIR ENTRY	1
10	000-909	CLAMP - HOSE - 80/100mm	1
11	000-910	CLAMP - HOSE - 90/110mm	1
12	956-123-400	DUCT - AIR ENTRY (SS1070HF)	1
13	000-958-450	POP RIVET - ALUMINIUM - 4.8mm x 21mm	8
14	000-226	CLIP - SPIRE - 4.8 x 2.5/3.7mm	3
15	000-951-550	SCREW - S/T - 4.8mm x 16mm (BLACK)	3
16	000-987-178	TIE STRAP - NYLON - 4.8mm x 178mm	1
17	000-441-200	SLEEVE - AIR RAM	1
18	000-914/B	CLAMP - HOSE - No. 56 (BLACK)	1
19	956-017-000	TEMPLATE - OUTER FENDER	1
20	956-017-200	TEMPLATE - INNER FENDER	1
21	956-017-300	TEMPLATE - FENDER LINER (FRONT)	1
22	956-017-400	TEMPLATE - FENDER LINER (REAR)	1
23	956-017-600	TEMPLATE - AIR CLEANER HOUSING (SS1070HF)	1



# SS1070HF

Jeep JK Wrangler 2012 Model  
3.6Litre VVT V6 Petrol (Pentastar Engine)

## Installation Guide

### Fitment to:

- Right Hand Side

### Fitting Time:

- 210 min

### Special Tools:

- Body Saw (Reciprocating)
- Step Drill
- T40 Torx Bit
- 5mm (13/64") Drill Bit
- Pop-Rivet Gun (Swivel Head)
- Touch-up Paint
- Sikaflex 227 (adhesive sealant)
- Loctite 243 (thread lock)
- Loctite 406 Instant Adhesive
- Clip Removing Tool
- 12"/18" Adjustable Wrench
- Prep Wash
- Masking Tape

**Prior to commencing the installation, it is the installer's responsibility to verify that all components and particularly the template (Item 19) are correct.**

2

Jack the vehicle up, remove the right hand front wheel and place the vehicle on a suitable axle stand.

Remove the RHS inner fender liner. (The 3 rear plastic pop rivets must be removed as shown).



Remove Plastic Pop Rivets

3

Remove the following in accordance with the factory service manual:

- Radio antenna
- Air cleaner assembly

4

Remove and discard the:

- Air intake from the air cleaner housing.
- ‘Sport’ sticker from the RHS fender. (Use prep wash to remove any sticky residue).



5

Tape the outer fender template (Item 19) to the rear and upper edges of the right hand fender. Use a felt tip pen to mark the 3 hole positions and the required fender panel and flare cut out area. Remove the template.

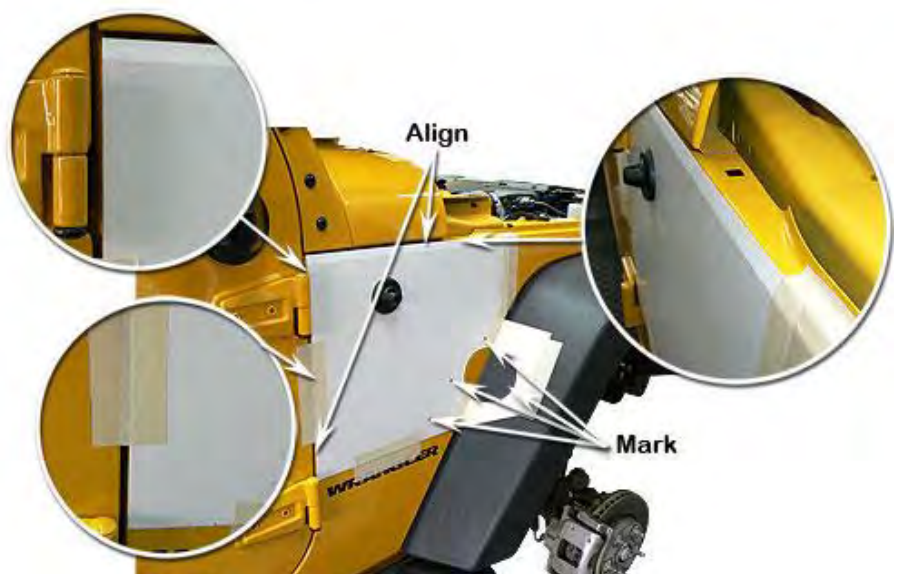

6

Position the inner fender template (Item 20) over the 2 flare clips. Using a felt tip pen, mark the required fender panel area which needs to be removed.

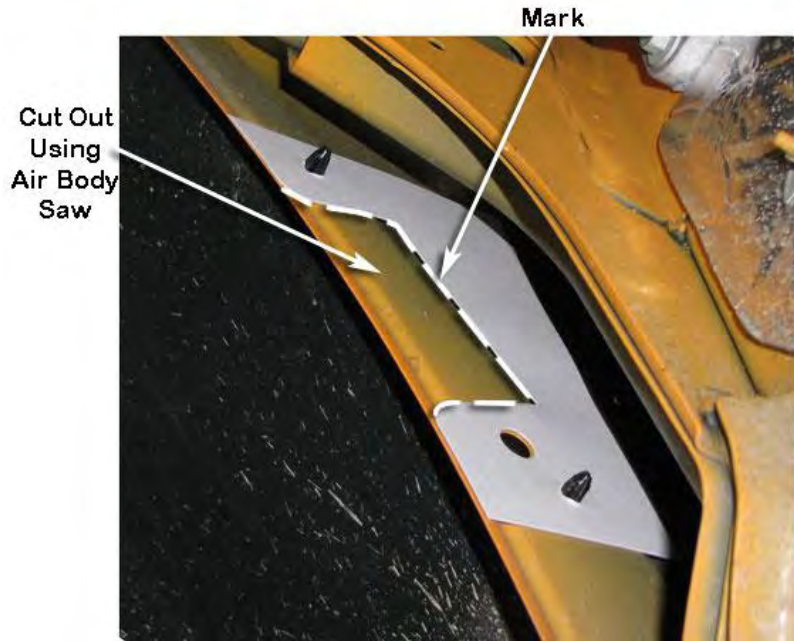

7

Use an air body saw to remove the marked area of the inner fender panel, outer fender panel and flare.

Drill pilot holes for the three marked mounting hole positions. Use a step drill to drill the 3 mounting hole positions to 16mm.

De burr and paint the three mounting holes and exposed metal surfaces to prevent rust.



Cut Using Air Body Saw

8

Using a 12" or 18" adjustable wrench or specialized panel beating equipment, bend the lower "A" Pillar reinforcement panel inwards (Be sure to bend the panel far enough inwards).

This process is critical to ensure that adequate clearance is achieved for the fitment of the air entry hose (Item 9).

Prepare the surface and paint to prevent the panel from rusting.



9

Remove the two standard bolts from the 'A' Pillar and install the two plastic spacers (Item 5) into the two 'A' Pillar bolt reliefs.

Apply Loctite 243 to the two standard 'A' Pillar bolts and install the upper mounting bracket (Item 3) onto the 'A' Pillar.

Fasten bolts in accordance with the factory service manual.

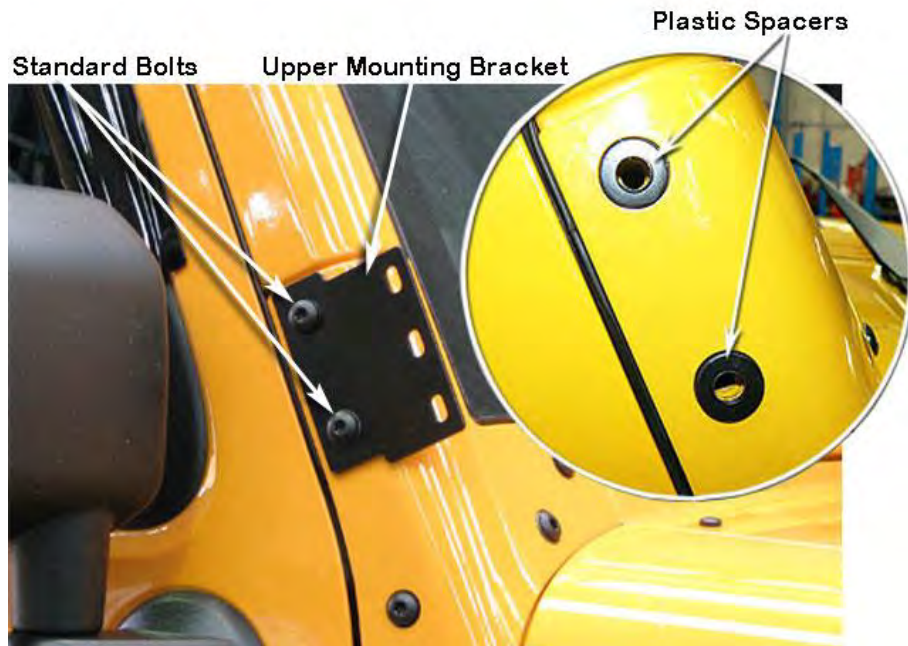

10

Apply Loctite 243 to each of the stainless steel mounting studs (Item 6) and install the studs finger tight into the snorkel body inserts.

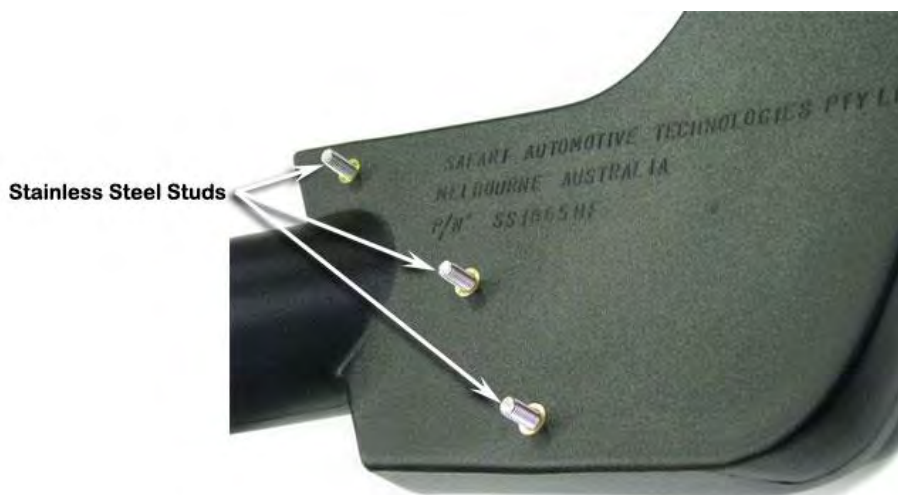

11

Measure 65mm down from the top of the snorkel body and mark the circumference.

Slide the air ram sleeve (Item 17) over the top of the snorkel body (Item 1) and align the bottom of the sleeve with the 65mm mark. Lift the edges of the sleeve (Item 17) and apply several small dabs of Loctite 406 Instant Adhesive or similar to secure the sleeve in position.



12

Install the snorkel body onto the fender panel.

Align the snorkel body to the upper mounting bracket and fender panel. When correctly aligned, fasten the snorkel body to the fender panel with body washers (Item 7) and nyloc nuts (Item 8).

Fasten the snorkel body to the upper mounting bracket with hex bolts (Item 4).



13

Unclip the wiring harness from its mounting position. Mark 80mm down (3.2") from the top of the air cleaner housing mounting bracket as shown.

Use an air body saw to cut away the required section of the air cleaner housing mounting bracket as shown. Ensure that the wiring harness is clear of the saw blade whilst cutting.

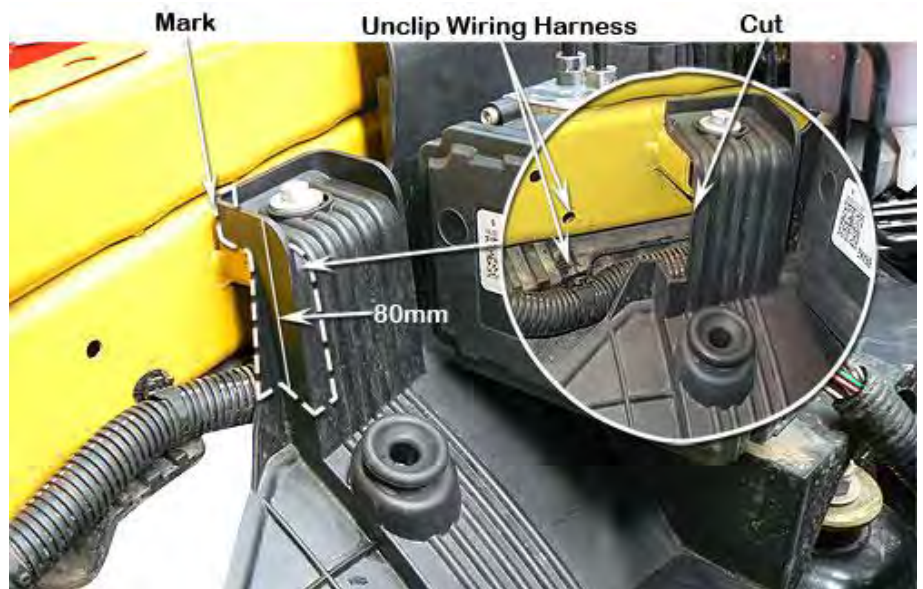

14

Mark the lower section of the plastic air cleaner housing mounting bracket as shown.

Use an air body saw to cut away the required section of the air cleaner housing mounting bracket.

De-burr and file all rough edges.

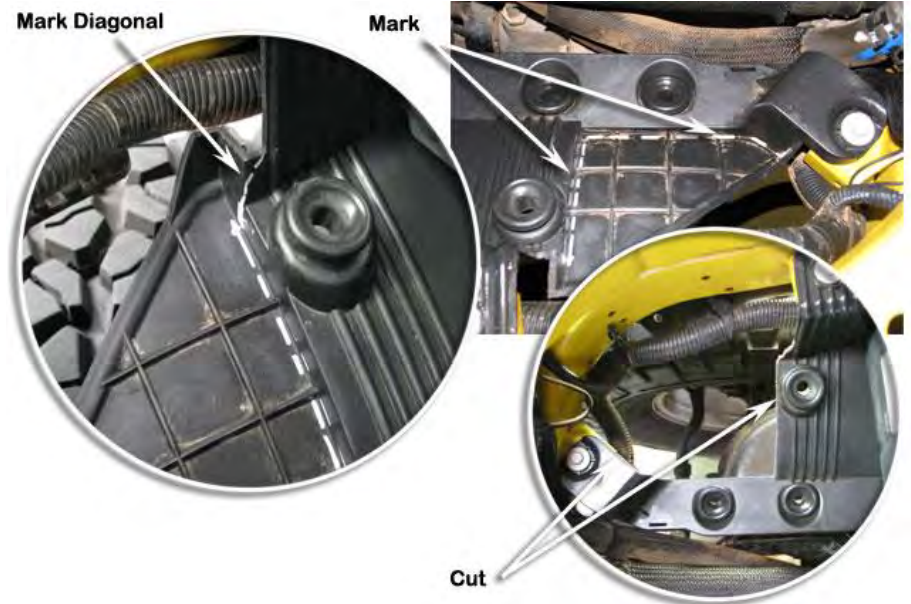

15

Mark the sections of the fender flare support bracket that must be removed as shown.

Use an body saw to cut-off the marked sections.

Ensure that the wiring loom is clear of the saw blade whilst cutting.

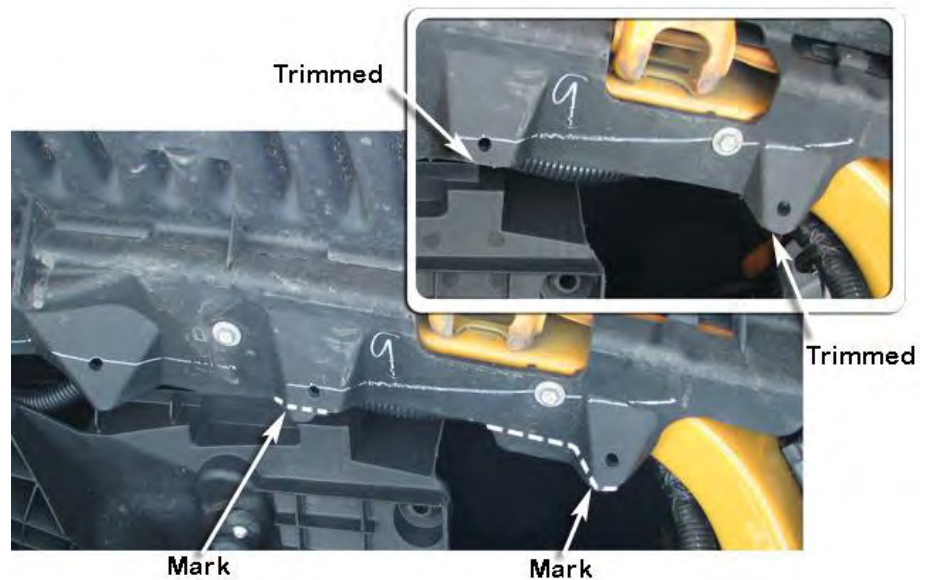

16

**LHD VEHICLES ONLY:**

The air cleaner / battery mount bracket requires areas of ribbing reduced in height to achieve adequate clearance to the air cleaner duct as shown.

Using a grinder, reduce the height of the highlighted ribbing.

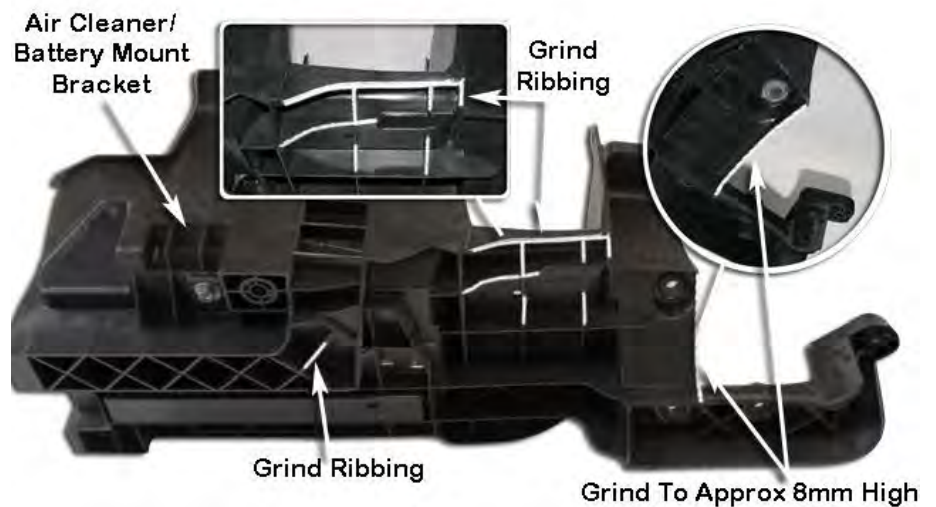

17

Use a grinder to remove the intake snout from the air cleaner base.

Hint: Remove the four lid retaining clips to make it easier to handle the air cleaner base.



18

Position the air cleaner housing template (Item 23) to the underside of the air cleaner base, locate the template over two of the air cleaner base mounting pins and align to the third pin as shown, mark the required air inlet hole profile and hole position.

Use an air body saw to cut away the marked section of the air cleaner base and discard the centre cut piece drill the marked hole position with a 5mm drill bit.

Use a file to de-burr and smooth any rough edges in the air cleaner base opening.





19

Place a strip of masking tape on the air cleaner base as shown, measure and mark a line 44mm in from the side of the lid retaining clip mount.

Position the air entry duct (Item 12) over the air cleaner base, align the centre moulding line of the duct to the marked line and press down firmly.

With the air entry duct correctly positioned onto the air cleaner base, mark the seven hole positions onto the air cleaner base, mark the hole position onto the duct from inside of the air cleaner base.



20

Drill the seven marked hole positions on the air cleaner base with a 5mm (13/64") drill bit, drill the marked hole position on the duct with a 5mm drill bit.

De-burr holes.



**21**

Install the air entry duct (Item 12) up through the air cleaner housing mounting bracket trimmed previously. Install a 90/110 hose clamp (Item 11) at the front end and a 80/100 hose clamp (Item 10) at the rear end of the air entry hose (Item 9). Install the air entry hose to the snorkel body outlet and the air entry duct. Do not tighten the hose clamps yet.



**22**

Reposition the wiring loom to the upper holes. Apply a thick coating of adhesive sealant to the air entry duct (Item 12) surfaces that will be mating with the bottom surface of the air cleaner base.

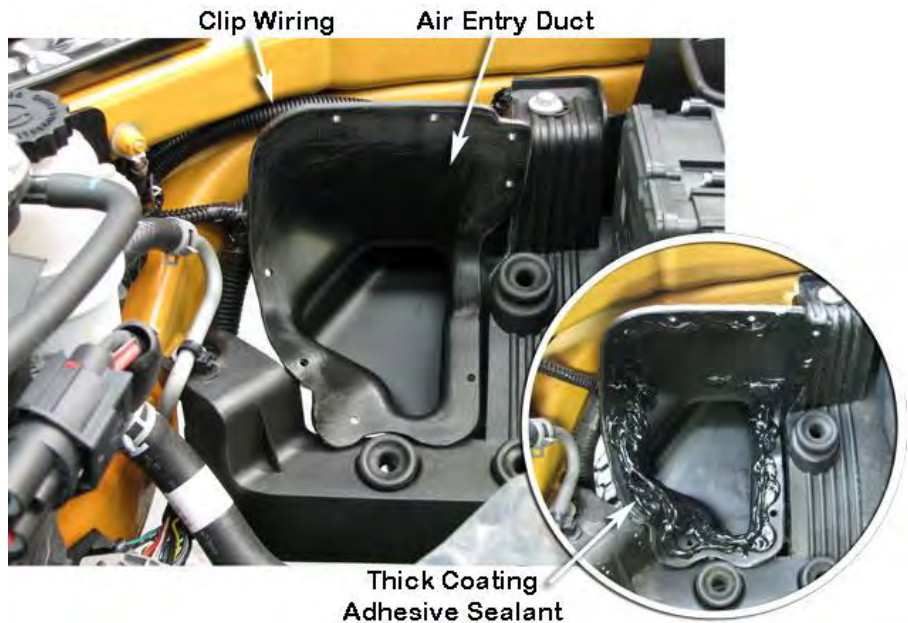

**23**

Reinstall the four air cleaner lid retaining clips to the air cleaner base and apply lubricant to the rubber air cleaner mounting bushes. Apply a generous coating of adhesive sealant to the underside surfaces of the air cleaner base that will be mating with the air entry duct (Item 12). Install the air cleaner base and install all eight pop rivets before securing with the pop rivet gun. Clean-up any excess adhesive sealant to ensure a neat finish.

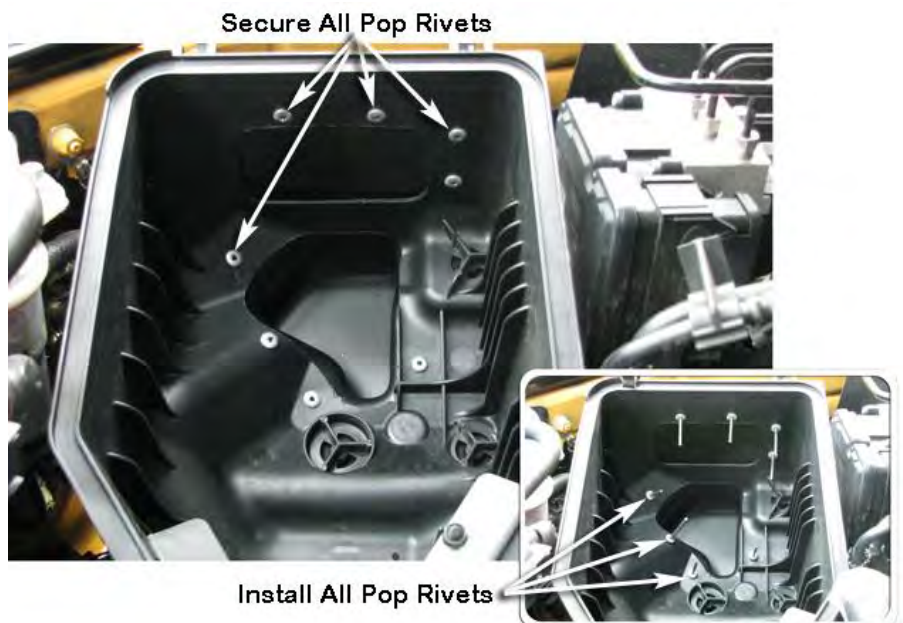

24

The three air cleaner base mounting pins must be sealed, apply adhesive sealant to completely seal the mounting pins as shown.

The air cleaner base also contains one small drain hole, It is up to the installer to decide whether the drain hole should be sealed.

Wipe away and smooth out any excess adhesive sealant.



25

Adjust the position of the air entry hose (Item 9) installed earlier for a relaxed fit.

Tighten the hose clamps (Items 10 & 11) at each end of the air entry hose (Item 9).

Reinstall the air filter element, air cleaner housing lid and connect wiring.



26

Mark and cut the inner fender liner as shown.

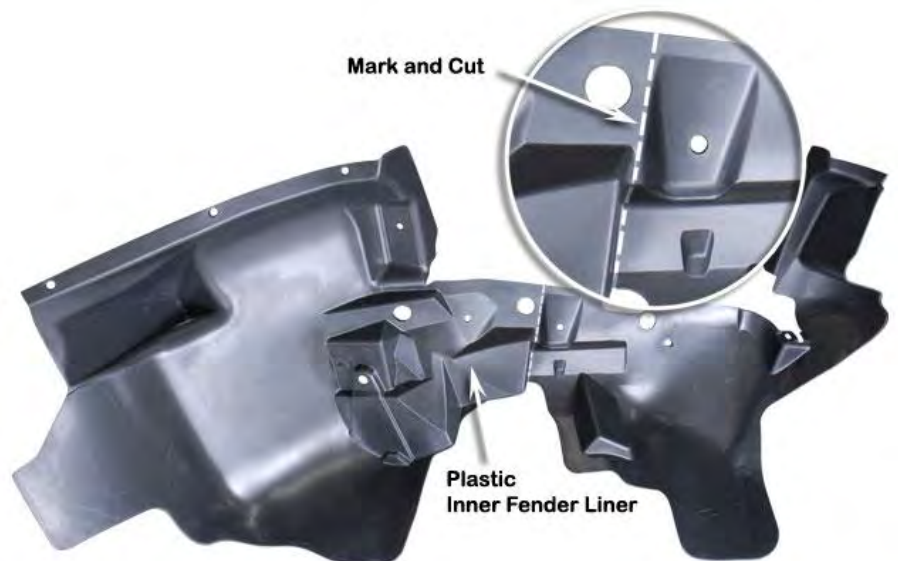

27

Align the front inner fender liner template (Item 21) to the engine bay side of the front section of the plastic fender liner as shown. Retain with masking tape.

Mark the outline of the noted section of the fender liner to be cut and the hole position as shown.

Use a body saw to cut the marked section out from the front section of the plastic fender liner. Drill the marked hole position with a 5mm (13/64") drill.



28

Align the rear inner fender liner template (Item 22) to the front wheel side of the plastic fender liner as shown. Retain with masking tape. Mark the outline but do not cut yet.

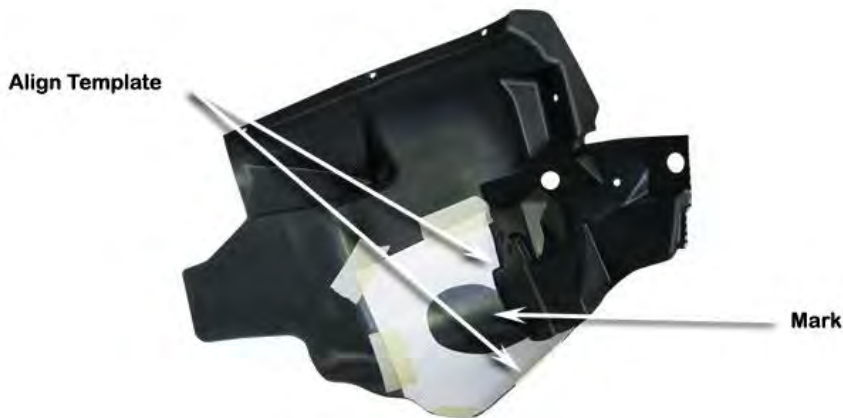

29

Extend the cutting path as shown. Maintain approximately a 15mm (9/16") below the corner ridge shown.

Use a body saw to cut the marked section out from the rear section of the plastic fender liner.

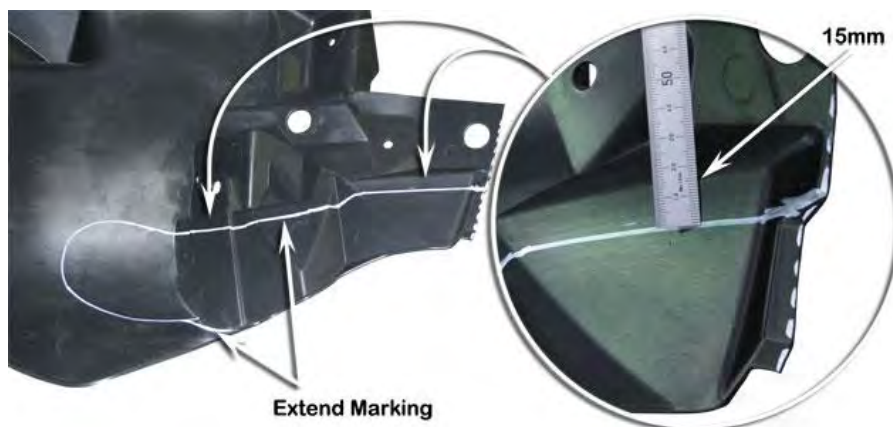

30

Trail fit the rear plastic inner fender liner and mark areas shown for additional trimming.

Trim marked areas to achieve a neat fit and finish.

Mark & Trim



31

Trial fit the front section of the fender liner and if required, make further trimming adjustments for a neat fit.

Install the front section of the fender liner and secure with the standard clips.

Drill a 5mm (13/64") hole into the shocker tower and with a small file, elongate the hole for the plastic tie strap. Deburr and paint the hole to prevent rust.

Inner Fender Liner (Front Section)

Drill 5mm

Tie Strap

Air Entry Duct



32

Install 3 spire clips (Item 14) to the three rear fender liner holes.

Install the rear section of the inner fender liner. Secure in place with the standard clips and standard tube nut.

Spire Clip

Inner Fender Liner (Rear Section)

Standard Tube Nut

Air Entry Hose

Air Entry Duct

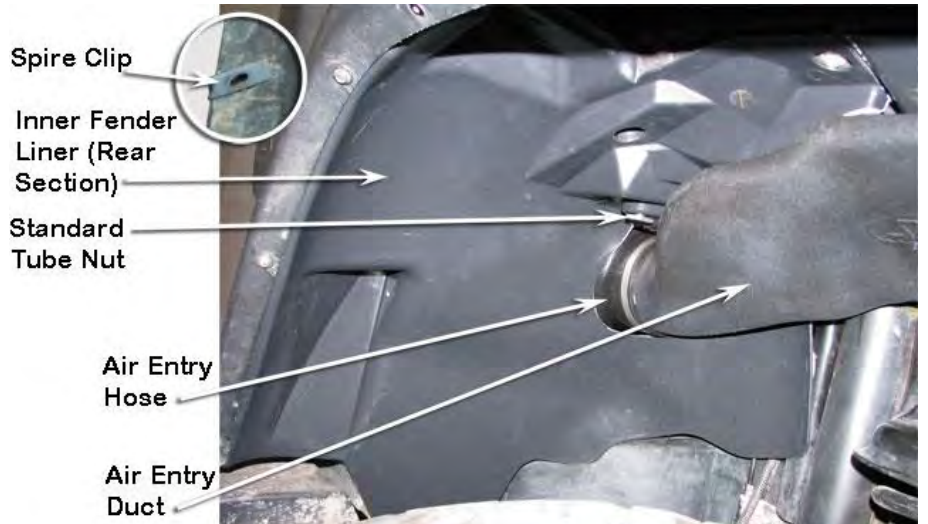

33

Install three self tapping screws (Item 15) through the fender flare and into the three spire clips (Item 14)



34 Refit the right front wheel, radio antenna and any other components that may have been removed during the installation process.

35

Loosely install the black hose clamp (Item 18) to the base of the air ram assembly (Item 2).

Install the air ram assembly onto the snorkel body. Align the air ram assembly and tighten the black hose clamp (Item 18).



36 **N.B: It is the installer's responsibility to ensure that all connections are water tight.**